

Step 3. Valve and Test Cock Winter Positions

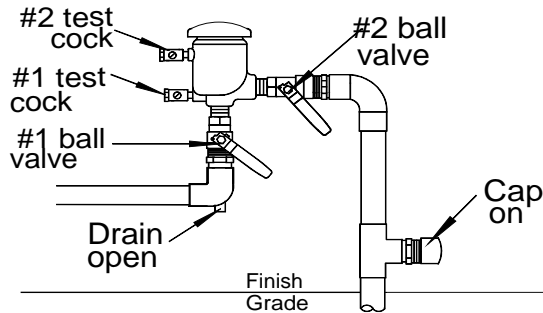

1. Leave the interior drain open over winter.
2. Leave both ball valves and both test cocks open at 45 degrees.
3. Leave exterior upstream drain open, if present.
4. Replace the air port cap.

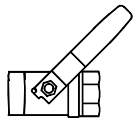

**Ball Valve
open at 45°**

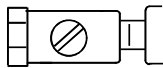

**Test Cock
open at 45°**

This pamphlet is designed to be a guide to help prevent damage to backflow prevention assemblies due to winterization techniques and practices. CBPA cannot be responsible for any damage which may occur to any backflow prevention assembly, irrigation system, plumbing system or component thereof as a result of using these guidelines.

Colorado Backflow Prevention Association
Visit us: www.backflow.org

Contact us: info@backflow.org

Or visit the
American Backflow Prevention Association
www.abpa.org

This brochure provided by:

Morrison Backflow Testing

(303)566-0182

with the assistance of the:

Colorado Backflow Prevention Association



© CBPA 2005

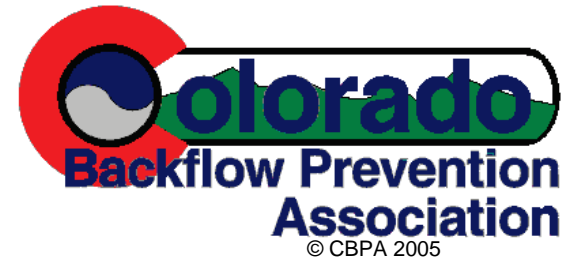

Winterizing
Residential
Irrigation
Backflow
Prevention
Assemblies

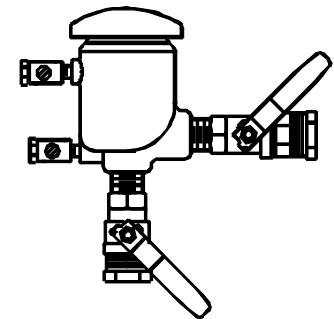

**Pressure Vacuum
Breaker**

Step 1. Shut off Water and Drain PVB

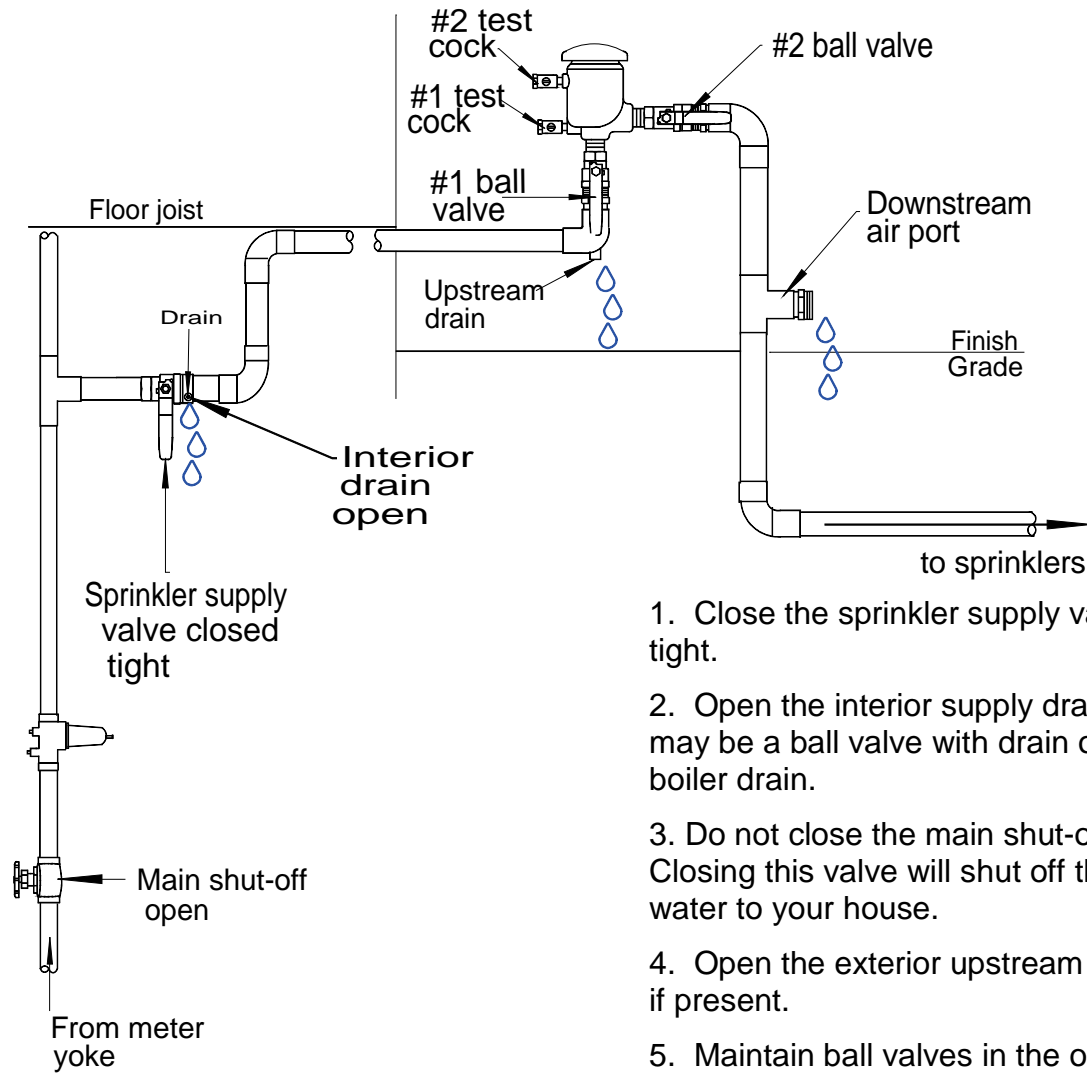

1. Close the sprinkler supply valve tight.
2. Open the interior supply drain; this may be a ball valve with drain or a boiler drain.
3. Do not close the main shut-off. Closing this valve will shut off the water to your house.
4. Open the exterior upstream drain, if present.
5. Maintain ball valves in the open position.
6. Open both test cocks.
7. Remove cap from downstream air port.
8. Allow water to drain from PVB and piping.

Step 2. Attach Compressor and Purge Water from System

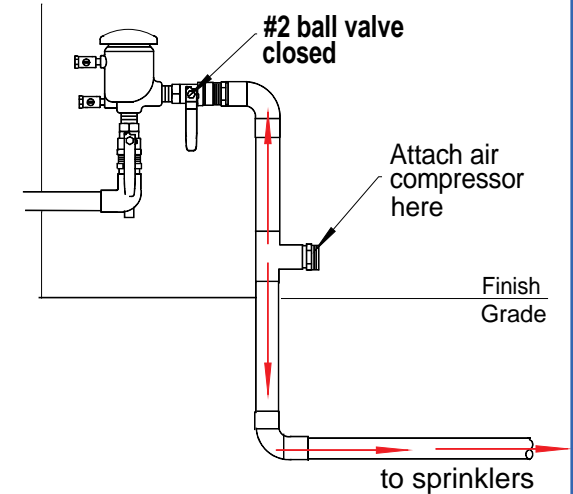

- 1. CLOSE THE #2 BALL VALVE.**
2. Attach air compressor to downstream air port.
3. Set the first station on the sprinkler timer to "Run."
4. Turn on the air from the air compressor.
5. Using the sprinkler timer, run each zone until only air comes out of the heads.

Continued on Back